

NEO·GEO™

SERVICE
MANUAL

MV-1FZ

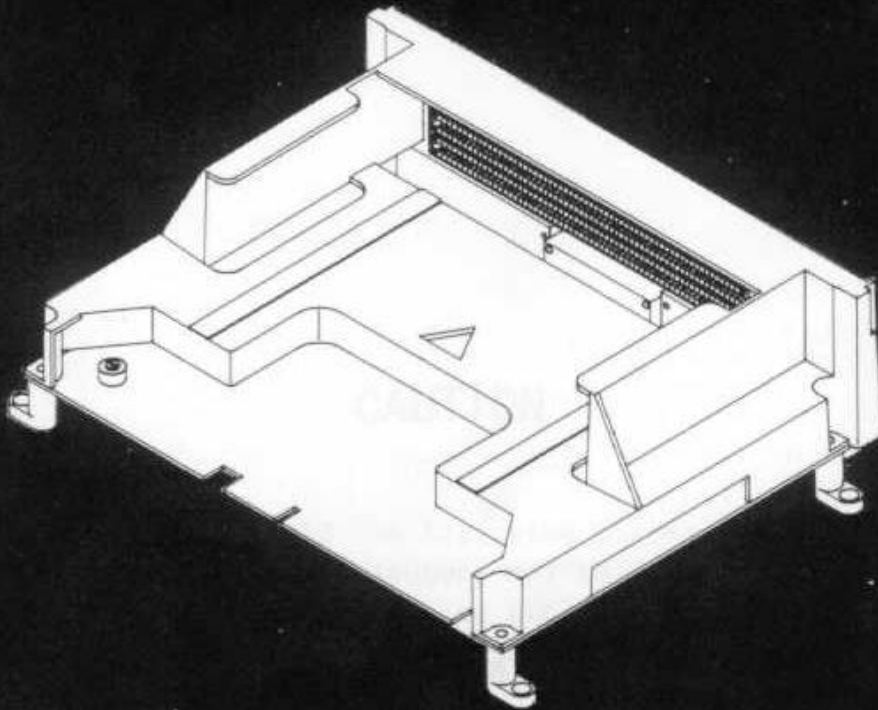

SNK

INTRODUCTION

Welcome to the NEO-GEO MULTI VIDEO SYSTEM. This unique system by SNK enables you to save space and maximize your income with PCBs of high quality and of easy maintenance.

The newly developed MV-1FZ has been more compactly designed than any former PCBs for carrying one NEO-GEO game, and the PCB can be directly connected to the JAMMA standardized cabinet.

Income data keeping and other featured functions of all NEO-GEO systems are of course available with MV-1FZ, too.

Please read this service manual carefully before starting to use the MVS and keep it at your side for further reference.

☆JAMMA...Japan Amusement Machinery Manufacturers Association

CAUTION

◇To set up the MVS, avoid the following places:

- *Where leaks or dew from moisture may be caused
- *Humid places like indoor swimming pools and showers
- *Where direct heat strikes or in the hot air
- *Near ignitable or volatile chemicals and other dangerous articles
- *Near emergency exits or fire extinguishers
- *Inclined places or near vibrating places
- *Dusty places

◇Keep the temperature between 5°C and 40°C .

◇Do not put heavy objects on top of the PCBs.

◇Use the power supply at DC5V±1%.

CONTENTS

NOTES	1
INTRODUCTION	2
CAUTION	2
CONTENTS	3
COMPONENTS	4
1 SETTING THE SOFT CARTRIDGES	4
-1 BEFORE SETTING	5
-2 SETTING CARTRIDGES	5
-3 POWER ON	5
2 MODE SETTING	5
-1 STARTING	6
-2 MAIN MENU	6
-3 HARDWARE TEST	7
-4 SETTING THE HARDWARE DIP	10
-5 SETTING THE SOFTWARE DIP	10
-6 INCOME DATA KEEPING	12
-7 SETTING THE CODE NUMBER	15
-8 SETTING THE CALENDAR	15
MAIN HARNESS	16
WIRING DIAGRAM	17
DIMENSION	18

PCB PARTS

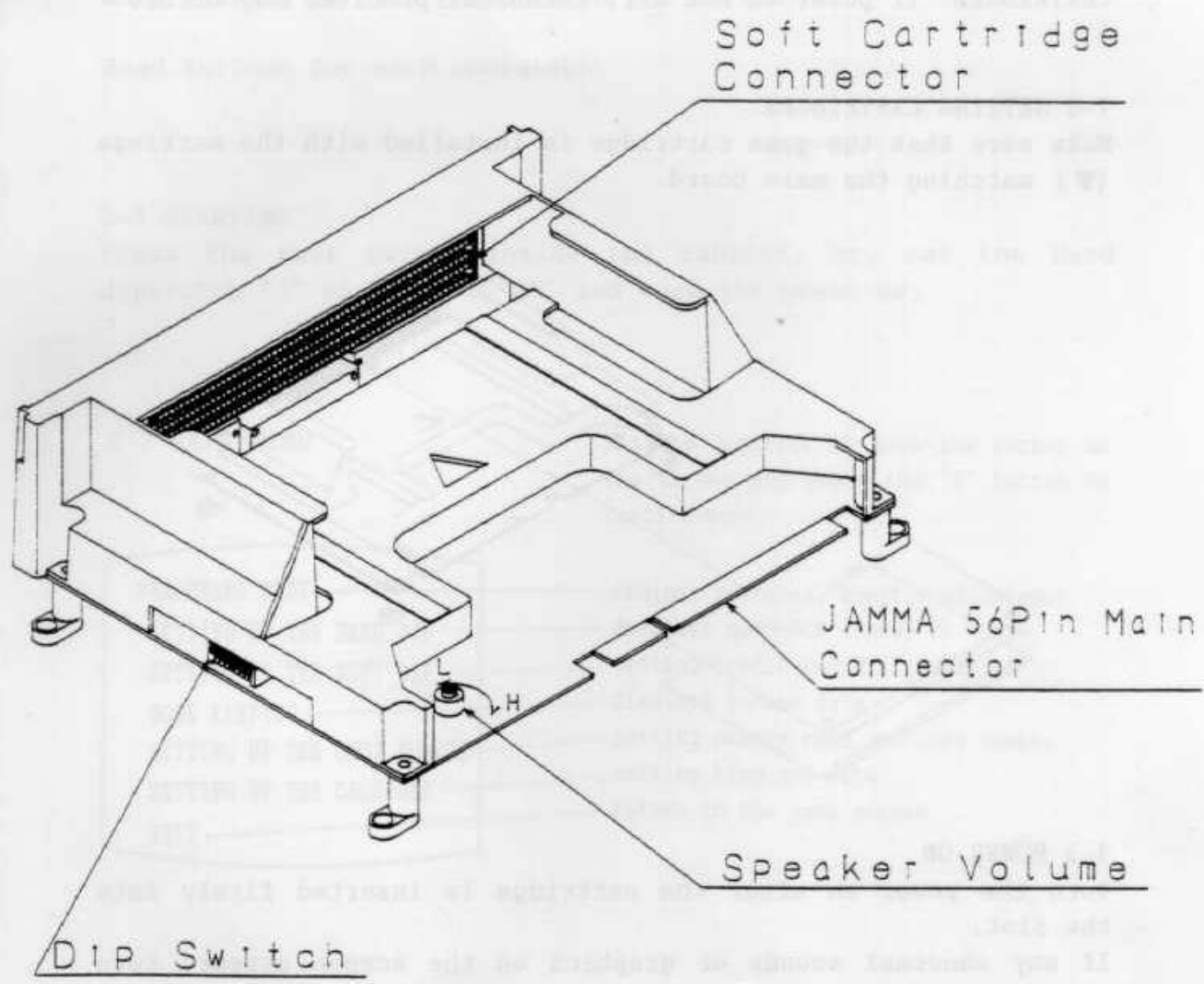

1. SETTING THE SOFT CARTRIDGES

1-1 BEFORE SETTING

MAKE SURE THAT POWER IS OFF WHEN YOU INSERT OR REMOVE THE CARTRIDGES. If power is not off, technical problems may occur.

1-2 SETTING CARTRIDGES

Make sure that the game cartridge is installed with the markings (▼) matching the main board.

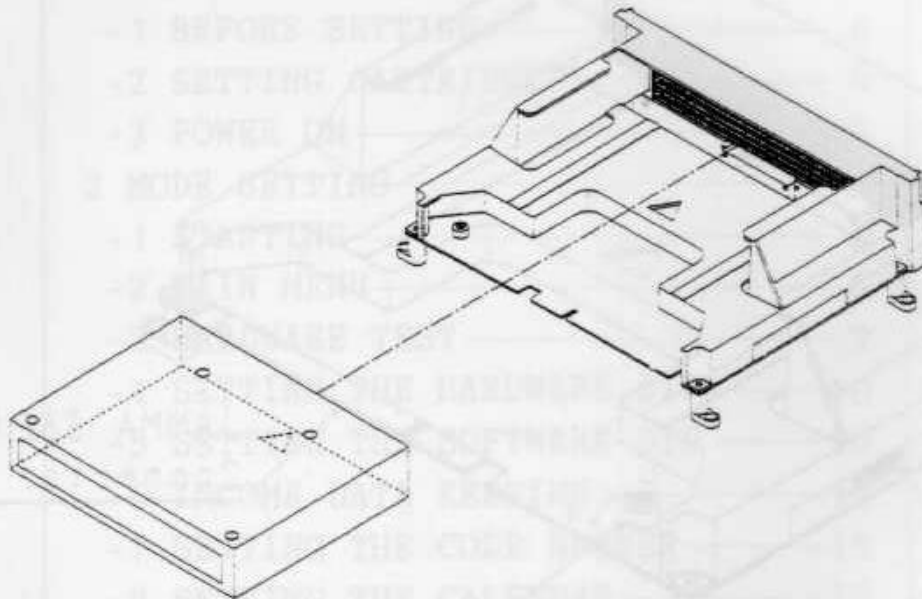

1-3 POWER ON

Turn the power on after the cartridge is inserted firmly into the slot.

If any abnormal sounds or graphics on the screen appear, turn off the power immediately and try the procedure again.

CAUTION: †Keep the slot from collecting dust and conductive things.

†Do not insert anything other than the NEO-GEO MVS cartridge. NEO-GEO HOME USE CARTRIDGES cannot work on MV-1FZ.

2. MODE SETTING

The MVS enables dip settings on the monitor screen instead of the Hard dipswitch settings on the PCBs of other systems. Income data keeping is also possible on the screen.

Read further for each operation.

2-1 STARTING

Press the test switch inside the cabinet, or, set the Hard dipswitch "1" on the PCB "ON" and turn the power on.

2-2 MAIN MENU

Use the joystick to move the cursor on the screen and press the "A" button to confirm mode.

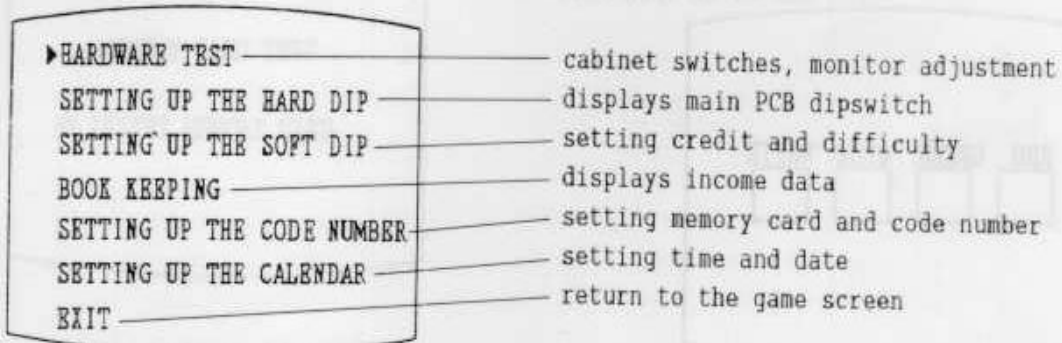

1. SETTING THE SOFT CARTRIDGE BITTES FROM S

2-3 HARDWARE TEST

Press the 1P start button to go to the next screen.

2-3-1 Crosshatch

Adjust position and size of the game screen here.

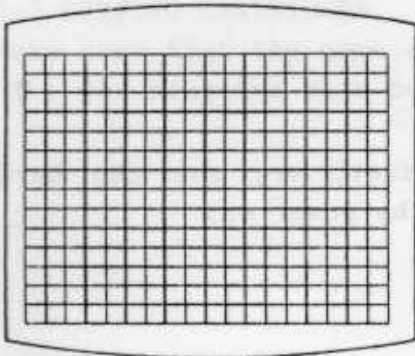

2-3-2 Color Adjustment

Adjust color on the screen.

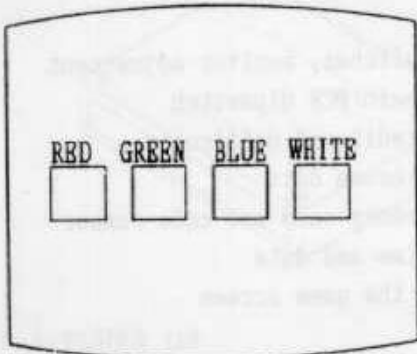

2-3-3 I/O Check

	I/O CHECK			
	P1	P2		
UP	0	0	00000000	
DOWN	0	0		
LEFT	0	0	TEST	0
RIGHT	0	0	COIN1	0
PUSH1	0	0	COIN2	0
PUSH2	0	0	SERVICE	0
PUSH3	0	0		
PUSH4	0	0	EL LED1 LED2	
START	0	0	0 00 00	
SELECT	0	0		

"1" stands for "on" and "0" for "off" of the dipswitch.

SELECT, EL, LED1 & LED2 are not used with MV-1FZ.

2-3-4 Sound Test

SOUND TEST
SOUND OFF
RIGHT
LEFT
CENTER

MV-1FZ IS FOR MONAURAL OUTPUT ONLY.
Sound at LEFT, RIGHT and CENTER are put
to the same speaker.

2-3-5 Memory Card Test

MEMORY CARD TEST
* INSERT MEMORY CARD

MV-1FZ doesn't have memory card
function. Go to the next.

2-3-6 Backup Clear

BACKUP CLEAR
OK=PUSH A, B, C BUTTON

You can clear all previous data (income
data, etc.) by pressing A, B & C buttons
at the same time.

2-3-7 Calendar

SETTING UP THE CALENDAR
CURRENT TIME
17/ 2/90 SAT
19:30:41
THE TIME TO BE SET UP
A BUTTON, JOYSTICK-SELECT
17/ 2/90 19:30:41

The time and date have already been set from the factory.

If needed, you can change the numbers indicated in red color. ("A" button to increase, "B" to decrease.)

Press "D" button to confirm setting.

After the HARDWARE TEST setting, turn the power off once. To return to the game screen, turn the power on again.

2-4 SETTING HARD DIP

Present status of the dipswitch is displayed. Press "C" button to return to the Main Menu.

SETTING UP THE HARD DIP		
	12345678	
SETTING MODE	1..... ON	Test Mode / Game Mode
COMMUNICATION	...000.. OFF	Set "0" (Normal Controller).
FREE PLAY0. OFF	communication plays
COIN SWITCH	..0..... 2	Game starts without inserting coins.
STOP MODE0 OFF	function to pause game
	0=OFF 1=ON	

2-5 SOFT DIP SETTING

2-5-1 Soft Dip Menu

Use the joystick to select and press "A" button to confirm mode.

▶SETTING UP THE CABINET	setting Credit for 1 coin
SLOT1 NAM-1975	setting difficulty
SLOT2 BASEBALL STARS	
SLOT3 MAHJONG	
SLOT4 TOP PLAYERS GOLF	
SLOT5 MAGICIAN LORD	

2-5-2 Cabinet Setting

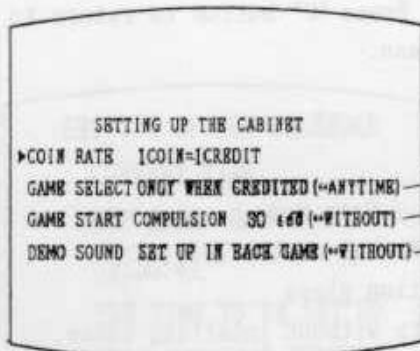

Use the joystick to move the cursor for each setting. Change mode with "A" and "B" button.

ineffect at MV-1FZ

Setting the time limit to start game
"WITHOUT" is selected, no sound even if "WITH" is set at CARTRIDGE SOFT DIP SETTING.

Press "C" button to go to the SOFT DIP SETTING Menu.

2-5-3 Soft Dip Setting

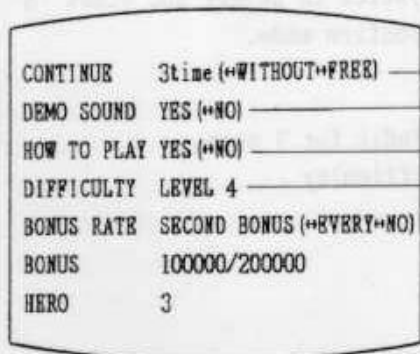

Setting menu differs by each game

- setting the number of CONTINUE PLAYS
- with or without demo sound
- with or without "HOW TO PLAY" screen
- setting difficulty of the game

Press "C" button to confirm the setting and the SOFT DIP SETTING menu will appear again. Press "C" button once more to get to the Main menu.

2-6 INCOME DATA KEEPING SYSTEM

2-6-1 Data Keeping

The MVS contains RAM for back-up and IC for calender in the system. Income and other data of the games being used are kept in the memory even when the power is off.

‡Data of a maximum 8 games can be kept at the MVS, even the game cartridges are removed from the PCB.

For example: 2 games, A & B are being used on the MVS. If new game titles C & D are used to replace A & B, the previous data for A & B will remain.

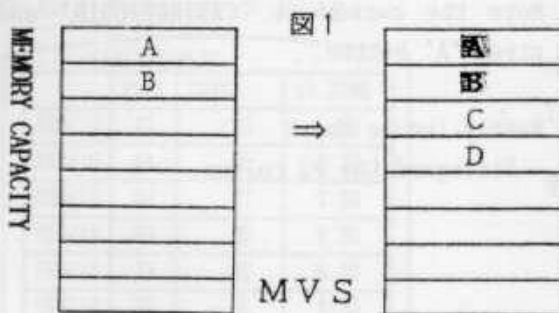

When the game cartridges, once removed, are set again later, new data will be added to the previous data.

When more than 8 games are used, the oldest game's data will be deleted from the memory to input data for the newest game.

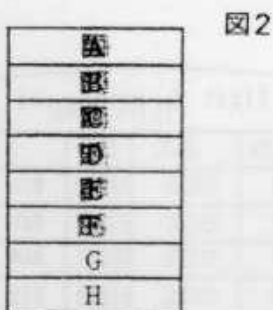

To go to the Income Data Keeping System, press the "TEST" button in the cabinet and select "BOOKKEEPING" mode on the screen.

2-6-2 Bookkeeping

▶CABINET/COIN
CABINET/PLAY
SLOT1 NAM1975
SLOT2 BASEBALL STARS
SLOT3 TOP PLAYERS GOLF
SLOT4 MAHJONG
SLOT5 MAGICIAN LORD

Move the cursor to "BOOKKEEPING" and press "A" button.

total income of the cabinet
total plays, continue plays of the cabinet
total plays, continue plays for each title.

2-6-3 Cabinet / Coin

CABINET/COIN			
	P1	P2	SERVICE
FEB/17	02244	0	25
FEB/16	04422	0	36
FEB/15	06633	0	47
FEB/14	08844	0	48
FEB/13	02399	0	29
FEB/12	05699	0	94

Move the cursor to "CABINET/COIN" and press "A" button.

Weekly income chart
→ Disregard the P2 column.

CABINET/COIN			
	P1	P2	SERVICE
JAN	42244	0	25
FEB	44422	0	36
MAR	56633	0	47
APR	68844	0	48
MAY	72399	0	129
JUN	55699	9	294

Income for the first 6 months of the year

MY-1FZ MAIN HARNESS

CABINET/COIN			
	P1	P2	SERVICE
JUL	42244	0	25
AUG	44422	0	36
SEP	56633	0	47
OCT	68844	0	48
NOV	72399	0	129
DEC	55699	0	294

Income for the second 6 months of the year

2-6-4 Cabinet / Play

CABINET/PLAY			
	PLAY	CONT.	AV. TIME
FEB/17	22	33	5:20
FEB/16	44	55	6:20
FEB/15	66	77	7:20
FEB/14	88	99	8:20
FEB/13	23	32	9:20
FEB/12	56	55	4:20
FEB/11	11	88	5:20

Move the cursor to "CABINET/PLAY" and press "A" button.

Weekly income chart

CABINET/PLAY			
	PLAY	CONT.	AV. TIME
JAN	42244	33363	5:20
FEB	44422	35543	6:20
MAR	56633	37773	7:20
APR	68844	39983	8:20
MAY	72399	33232	9:20
JUN	55699	15519	4:20

Income for the first 6 months of the year

CABINET/PLAY			
	PLAY	CONT.	AV. TIME
JUL	42244	33363	5:20
AUG	44422	35543	6:20
SEP	56633	37773	7:20
OCT	68844	39983	8:20
NOV	72399	33232	9:20
DEC	55699	15519	4:20

Income for the second 6 months of the year

Income data of each game is shown in the same way as "CABINET/COIN" and "CABINET/PLAY".

2-7 SETTING THE CODE NUMBER

CODE NUMBER SETTING
 2408
 D BUTTON: SET
 CODE NUMBER WILL BE SET INTO
 *MEMORY CARD WHEN INSERTED
 DURING THIS MODE.

Not available on MV-1FZ

2-8 SETTING CALENDER

To set the calendar, refer to 2-3-7, HARDWARE TEST.

MV-1FZ MAIN HARNESS

WIRING DIAGRAM

SOLDER SIDE	PIN #		PART SIDE
G N D	A	1	G N D
G N D	B	2	G N D
+ 5V	C	3	+ 5V
+ 5V	D	4	+ 5V
	E	5	
+ 12V	F	6	+ 12V
KEY	H	7	KEY
COIN COUNTER 2	J	8	COIN COUNTER 1
COIN LOCKOUT 2	K	9	COIN LOCKOUT 1
SPEAKER (-)	L	10	SPEAKER (+)
AUDIO (GND)	M	11	
VIDEO GREEN	N	12	VIDEO RED
VIDEO SYNC	P	13	VIDEO BLUE
SERVICE SW	R	14	VIDEO GND
	S	15	TEST SW
COIN SW 2	T	16	COIN SW 1
START SW 2	U	17	START SW 1
2 P UP	V	18	1 P UP
2 P DOWN	W	19	1 P DOWN
2 P LEFT	X	20	1 P LEFT
2 P RIGHT	Y	21	1 P RIGHT
2 P PUSH 1	Z	22	1 P PUSH 1
2 P PUSH 2	a	23	1 P PUSH 2
2 P PUSH 3	b	24	1 P PUSH 3
2 P PUSH 4	c	25	1 P PUSH 4
	d	26	DATA INPUT SW
G N D	e	27	G N D
G N D	f	28	G N D

DATA INPUT SW is not used at normal use.

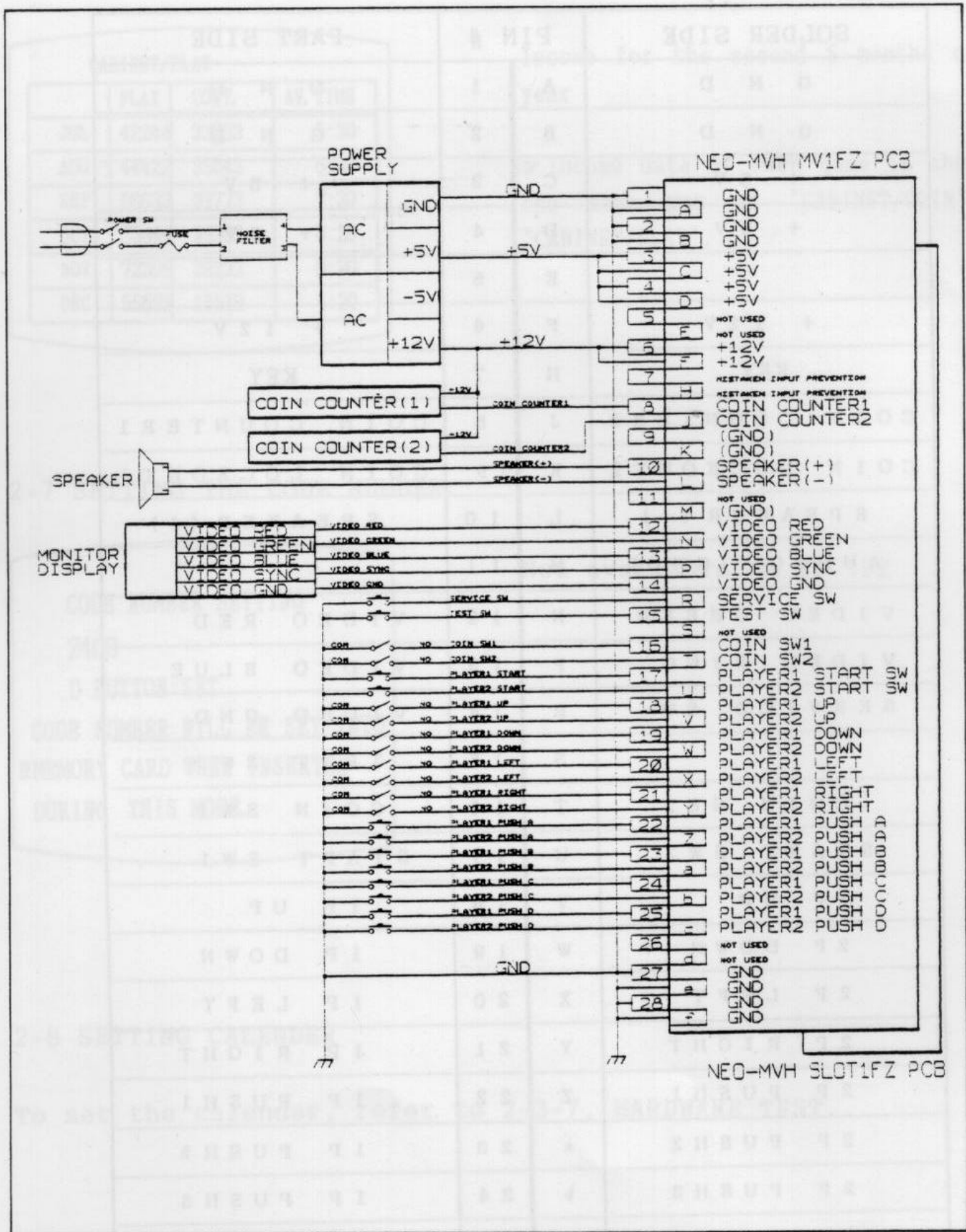

DIMENSION

NEO-GEO

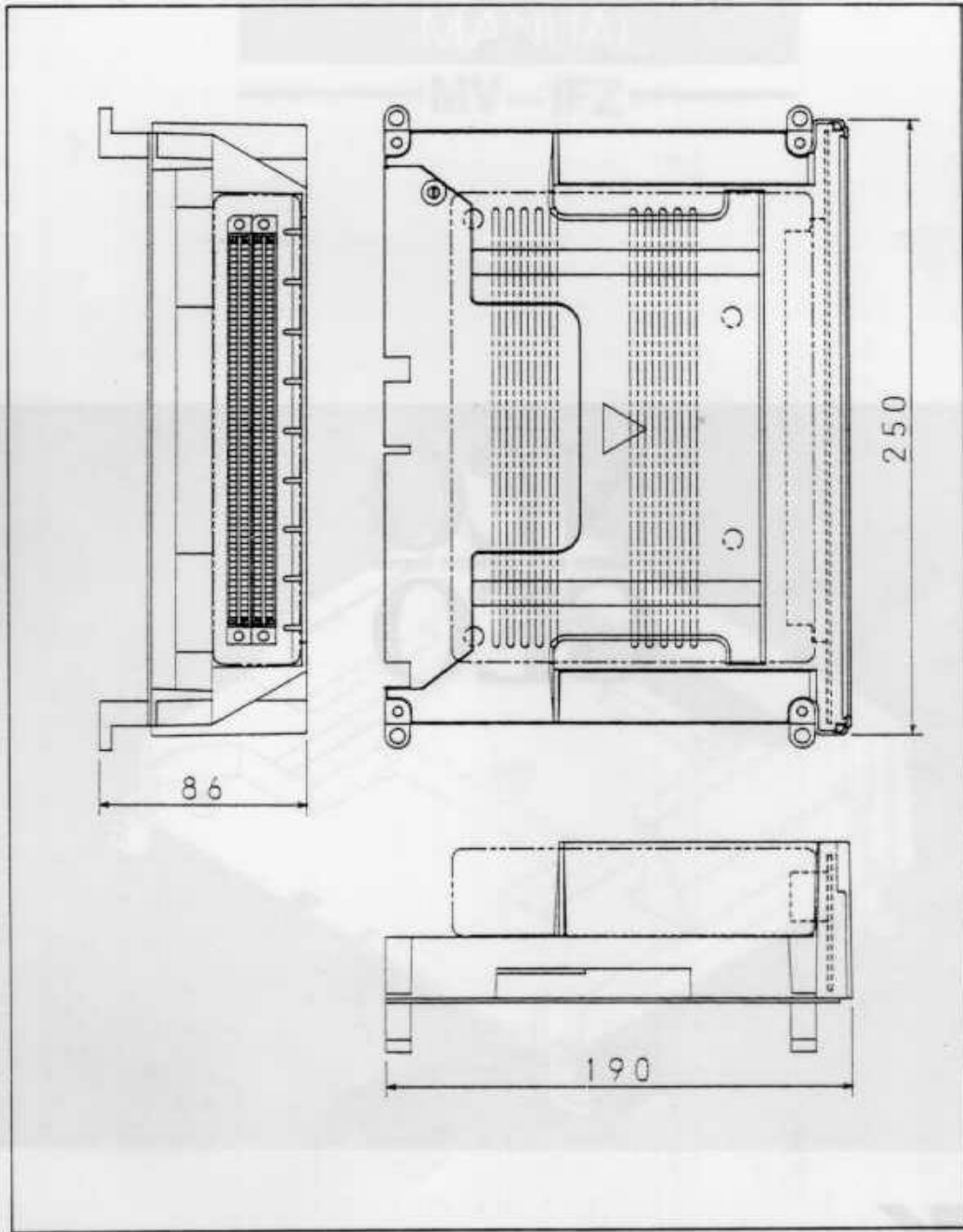

POWER SUPPLY	+ 5 V	7 A
	+ 12 V	1 A